

Schwingungsgedämpfte Bohrstangen

- **Schwingungsgedämpfte** Modulare Bohrstangen mit IK
Ø 40 / 50 / 60 mit CS40 Schnittstelle

gültig
ab
2025



kurzfristig ab Werk lieferbar















Spann- und Werkzeugtechnik
Technique d'outillage et de serrage

Top-
Qualität
zu Super-Preisen
Excellent rapport
qualité-prix













CS40 Bohrstangen

	ANS...05	Seite 4
	AFS...06	Seite 4
	AFS...08	Seite 4
	AFS...10	Seite 5
	AFS...12	Seite 5
	AFH...12	Seite 5
	AFH...14	Seite 5
	CS40-DCLN.-12	Seite 6
	CS40-DDQN.-15	Seite 6
	CS40-DDUN.-15	Seite 7
	CS40-DTUN.-16	Seite 7
	CS40-DTUN.-22	Seite 8
	CS40-DVUN.-16	Seite 8

CS40 Schnittstelle

	CS40-DWLN.-08	Seite 9
	CS40-DIR/L-16	Seite 9
	CS40-SCLC.-12	Seite 10
	CS40-SDQC.-11	Seite 10
	CS40-SDUC.-11	Seite 11
	CS40-STUC.-16	Seite 11
	CS40-SVUB.-16	Seite 12
	CS40-SVUC.-16	Seite 12
	CS40-PU10R/L	Seite 13
	CS40-XXR/L	Seite 13
	CS40-CIG.-20-11	Seite 14
	CS40-CIG.-30-11	Seite 14
	CS40-CIG.-40-11	Seite 15

Grundhalter

	CS40-CIG.-50-11	Seite 15
	MSS-ANS-	Seite 16
	MSS-AFS-	Seite 16
	MSS-E4-ER..	Seite 16
	BMT45 /55 /65 /75	Seite 17
	BMT40 / BMT 60	Seite 17
	BG2 / BG3	Seite 17
	DS1 / DS2	Seite 18
	TKT2	Seite 18
	NKM55	Seite 18
	CMZ30	Seite 19
	MZK40 / MZK50	Seite 19

Wozu werden schwingungsgedämpfte Bohrstangen gebraucht?

In vielen Firmen werden die Bauteile immer grösser und die zu bearbeitenden Bohrungen immer tiefer. Anspruchsvolle Toleranzen und beste Oberflächen Qualitäten werden immer mehr zum Brennpunkt in der Zerspaltung. Mit unseren **Cool Tool** Schwingungsgedämpften Bohrstangen und dem Revolution Aufnahmen Programm sind Sie für diese anspruchsvollen Aufgaben bestens gewappnet! Das große Bohrstangenprogramm bietet Ihnen die Möglichkeit Ihr Werkzeug optimal für Ihre Bearbeitung zu wählen.

Ausführungen und Unterscheidungsmerkmale der Modularen Bohrstangen

Prinzipiell lassen sich herkömmliche Bohrstangen und schwingungsgedämpfte Bohrstangen einfach unterscheiden: Die herkömmlichen Bohrstangen ohne schwingungsdämpfendes Element haben immer eine angefräste Spannfläche die zum einfachen Ausrichten und Spannen der Bohrstanze dient.

Unsere schwingungsgedämpften Bohrstangen haben nur eine kleine gefräste 90° Nut. Diese dient ausschliesslich zum Ausrichten der Bohrstanze und hat keine Spannende Wirkung. Schwingungsgedämpfte Bohrstangen müssen generell Vollumschlungen gespannt werden.

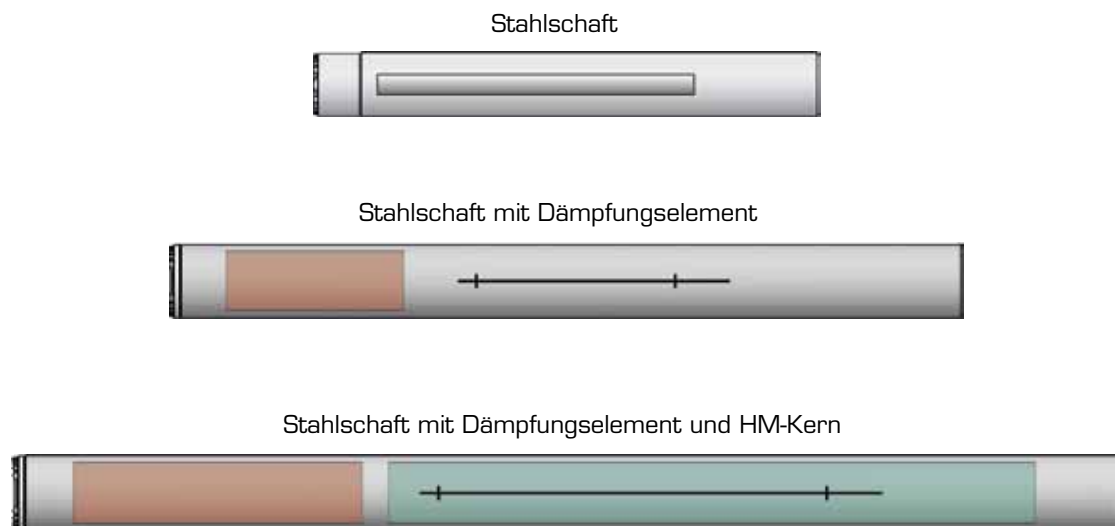

Die Bohrstangenköpfe

Die Bohrstangenköpfe sind unterteilt in:

CS20 siehe separaten Katalog

12 Modelle (rechts und links)

Beispiel eines CS20-Kopfes

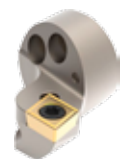

kann auf den Bohrstangen mit 20, 25 und 32 mm Durchmesser montiert werden.

CS40

18 Modelle (rechts und links)

Beispiel eines CS40-Kopfes



kann auf den Bohrstangen mit 40, 50 und 60 mm Durchmesser montiert werden.

Maximale Flexibilität Ein Kopf für mehrere Bohrstangendurchmesser

Schwingungsgedämpfte Monoblock Bohrstangen

ANS..-05

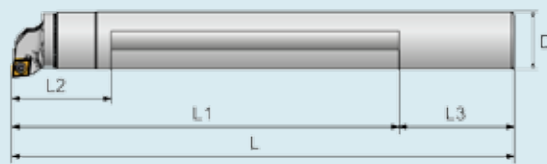

Art.-Nr.	Bezeichnung	D	Länge x D	L	L1	L2	L3		Preis	Schaft
30.221048	ANS40-05-328	40	5xD	360	280	72	80	VB0612 CBR50		Stahl
30.221049	ANS50-05-418	50	5xD	450	350	82	100	VB0612 CBR50		Stahl
30.221050	ANS60-05-508	60	5xD	540	420	92	120	VB0612 CBR50		Stahl

AFS..-06 Schwingungsgedämpfte Modulare Bohrstangen

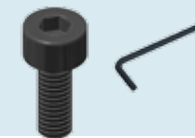
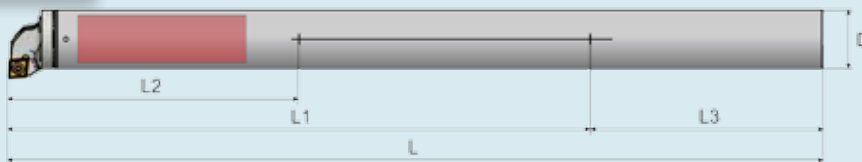

Art.-Nr.	Bezeichnung	D	Länge x D	L	L1	L2	L3		Preis	Schaft
30.221076	AFS40-06-368	40	6xD	400	240			VB0612 CBR50		
30.221084	AFS50-06-468	50	6xD	500	300			VB0612 CBR50		mit Dämpfungselement
30.221092	AFS60-06-568	60	6xD	600	360			VB0612 CBR50		

AFS..-08 Schwingungsgedämpfte Modulare Bohrstangen

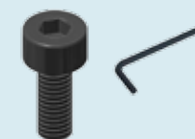
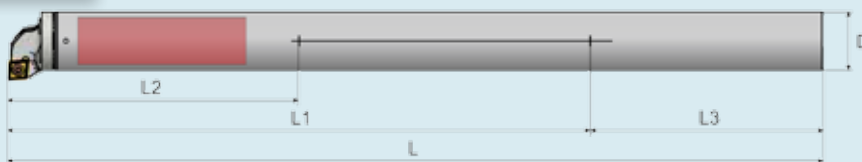

Art.-Nr.	Bezeichnung	D	Länge x D	L	L1	L2	L3		Preis	Schaft
30.221077	AFS40-08-448	40	8xD	480	320	180	160	VB0612 CBR50		
30.221085	AFS50-08-568	50	8xD	600	400	215	200	VB0612 CBR50		mit Dämpfungselement
30.221093	AFS60-08-688	60	8xD	720	480	247	240	VB0612 CBR50		

Schwingungsgedämpfte Modulare Bohrstangen

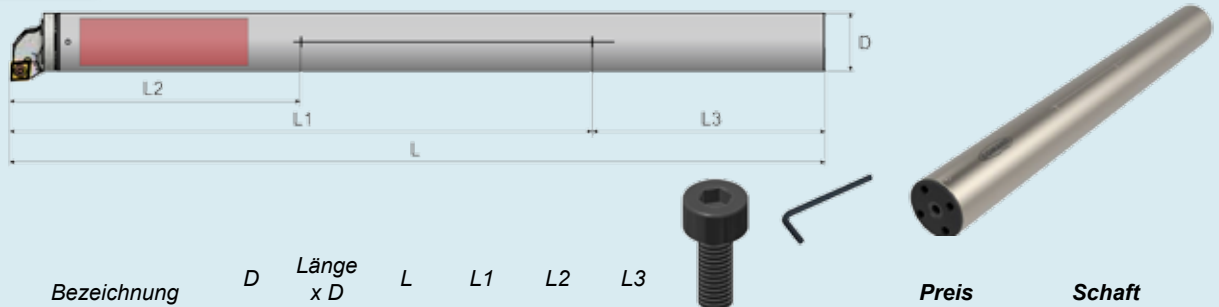
AFS..-10

Art.-Nr.	Bezeichnung	D	Länge x D	L	L1	L2	L3		Preis	Schaft
30.221078	AFS40-10-528	40	10xD	560	400	200	160	VB0612 CBR50		
30.221086	AFS50-10-668	50	10xD	700	500	245	200	VB0612 CBR50		mit Dämpfungselement
30.221094	AFS60-10-808	60	10xD	840	600	280	240	VB0612 CBR50		

Schwingungsgedämpfte Modulare Bohrstangen

AFS..-12

Art.-Nr.	Bezeichnung	D	Länge x D	L	L1	L2	L3		Preis	Schaft
30.221079	AFS40-12-608	40	12xD	640	480	215	160	VB0612 CBR50		
30.221087	AFS50-12-768	50	12xD	800	600	270	200	VB0612 CBR50		mit Dämpfungselement
30.221095	AFS60-12-928	60	12xD	960	720	325	240	VB0612 CBR50		

Schwingungsgedämpfte Modulare Bohrstangen mit Hartmetall-Kern

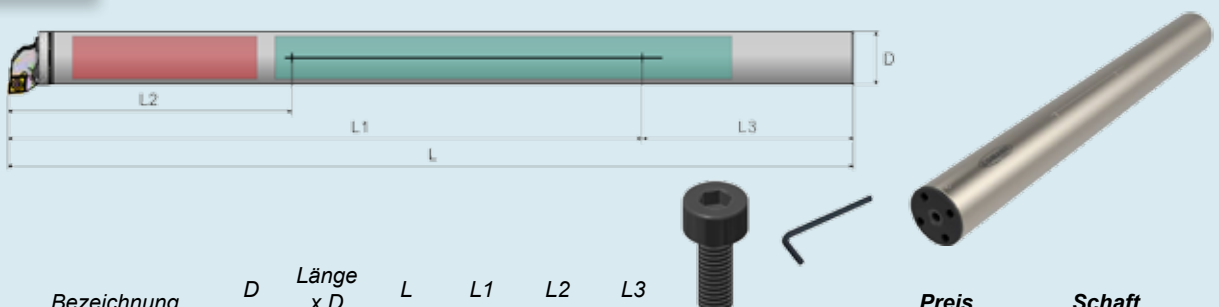
AFH..-12

Art.-Nr.	Bezeichnung	D	Länge x D	L	L1	L2	L3		Preis	Schaft
30.221082	AFH40-12-608	40	12xD	640	480	215	160	VB0612 CBR50		
30.221090	AFH50-12-768	50	12xD	800	600	270	200	VB0612 CBR50		mit Dämpfungselement und HM-Kern
30.221098	AFH60-12-928	60	12xD	960	720	325	240	VB0612 CBR50		

Schwingungsgedämpfte Modulare Bohrstangen mit Hartmetall-Kern

AFH..-14

Art.-Nr.	Bezeichnung	D	Länge x D	L	L1	L2	L3		Preis	Schaft
30.221083	AFH40-14-688	40	14xD	640	560	215	160	VB0612 CBR50		
30.221091	AFH50-14-868	50	14xD	800	700	270	200	VB0612 CBR50		mit Dämpfungselement und HM-Kern
30.221099	AFH60-14-1048	60	14xD	960	840	325	240	VB0612 CBR50		

CS40-DCLN.-12

Bohrstangenkopf CS40

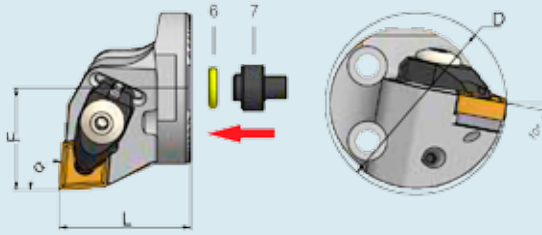

Art.-Nr.	Bezeichnung	Halter	Ø D min	L	F	Winkel	WSP	Preis
30.221145	CS40-DCLNR-12	A..40...	48	35	27	95°	CN..1204	
30.221146	CS40-DCLNL-12	A..40...	48	35	27	95°	CN..1204	
30.221147	CS40-DCLNR-16	A..40...	48	35	27	95°	CN..1606	
30.221148	CS40-DCLNL-16	A..40...	48	35	27	95°	CN..1606	
		A..50...	58					
		A..60...	68					

Ersatzteile



Bezeichnung	S8012P	VD0408	OR-SET	DT21R/L	V6017	OR-CS40	DM-05-000	CBR30
-------------	--------	--------	--------	---------	-------	---------	-----------	-------

CS40-DDQN.-15

Bohrstangenkopf CS40

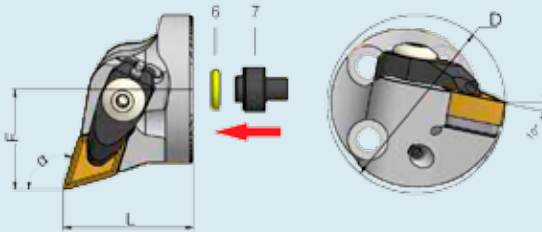

Art.-Nr.	Bezeichnung	Halter	Ø D min	L	F	Winkel	WSP	Preis
30.221152	CS40-DDQNL-15	A..40...	48	35	27	107.5°	DN..1506	
30.221151	CS40-DDQNR-15	A..40...	48	35	27	107.5°	DN..1506	
		A..50...	58					
		A..60...	68					

Ersatzteile

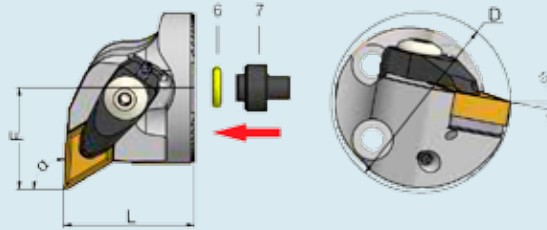

Bezeichnung	S5515D	VD0408	OR-SET	DT22R/L	V6017	OR-CS40	DM-05-000	CBR30
-------------	--------	--------	--------	---------	-------	---------	-----------	-------

CS40-DDUN.-15
Bohrstangenkopf CS40

Art.-Nr.	Bezeichnung	Halter	Ø D min	L	F	Winkel	WSP	Preis
30.221153	CS40-DDUNR-15	A..40...	48	35	27	93°	DN..1506	
30.221154	CS40-DDUNL-15	A..40...	48	35	27	93°	DN..1506	
		A..50...	58					
		A..60...	68					

Ersatzteile

Bezeichnung	S5515D	VD0408	OR-SET	DT22R/L	V6017	OR-CS40	DM-05-000	CBR30
-------------	--------	--------	--------	---------	-------	---------	-----------	-------

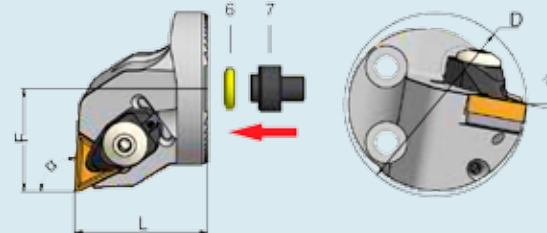
CS40-DTUN.-16
Bohrstangenkopf CS40

Art.-Nr.	Bezeichnung	Halter	Ø D min	L	F	Winkel	WSP	Preis
30.221159	CS40-DTUNR-16	A..40...	48	35	27	93°	TN..1604	
30.221160	CS40-DTUNL-16	A..40...	48	35	27	93°	TN..1604	
		A..50...	58					
		A..60...	68					

Ersatzteile

Bezeichnung	S6016D	VD0308	OR-SET	DT23R/L	V6017	OR-CS40	DM-05-000	CBR30
-------------	--------	--------	--------	---------	-------	---------	-----------	-------

CS40-DTUN.-22

Bohrstangenkopf CS40

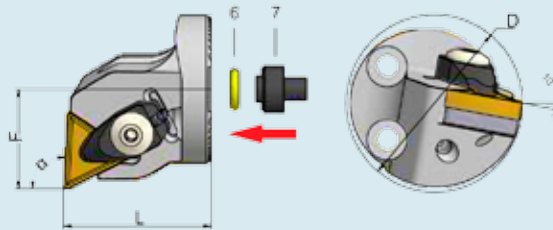

Art.-Nr.	Bezeichnung	Halter	$\varnothing D$ min	L	F	Winkel	WSP	Preis
30.221161	CS40-DTUNR-22	A..40...	48	40	27	93°	TN..2204	
30.221162	CS40-DTUNL-22	A..40...	48	40	27	93°	TN..2204	
		A..50...	58					
		A..60...	68					

Ersatzteile



Bezeichnung	S6022D	VD0408	OR-SET	DT21R/L	V6017	OR-CS40	DM-05-000	CBR30
-------------	--------	--------	--------	---------	-------	---------	-----------	-------

CS40-DVUN.-16

Bohrstangenkopf CS40

Art.-Nr.	Bezeichnung	Halter	$\varnothing D$ min	L	F	Winkel	WSP	Preis
30.221163	CS40-DVUNR-16	A..40...	48	35	27	107.5°	VN..1604	
30.221164	CS40-DVUNL-16	A..40...	48	35	27	107.5°	VN..1604	
		A..50...	58					
		A..60...	68					

Ersatzteile



Bezeichnung	VD0408	OR-SET	DT21R/L	V6017	OR-CS40	DM-05-000	CBR30
-------------	--------	--------	---------	-------	---------	-----------	-------

CS40-DWLN.-08

Bohrstangenkopf CS40

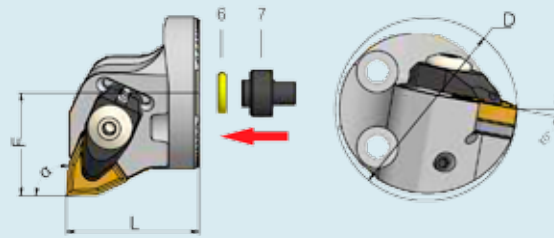

Art.-Nr.	Bezeichnung	Halter	$\varnothing D$ min	L	F	Winkel	WSP	Preis
30.221165	CS40-DWLN-08	A..40...	48	35	27	95°	WN..0804	
30.221166	CS40-DWLN-08	A..40...	48	35	27	95°	WN..0804	
		A..50...	58					
		A..60...	68					

Ersatzteile



Bezeichnung	S8008P	VD0408	OR-SET	DT21R/L	V6017	OR-CS40	DM-05-000	CBR30
-------------	--------	--------	--------	---------	-------	---------	-----------	-------

CS40-DIR/L-16

Bohrstangenkopf CS40

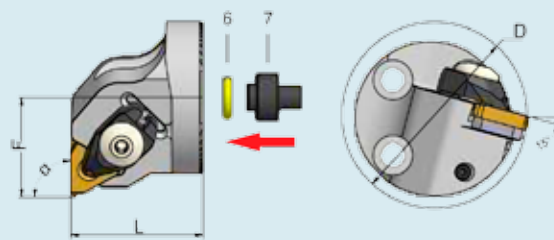

Art.-Nr.	Bezeichnung	Halter	$\varnothing D$ min	L	F	Winkel	WSP	Preis
30.221155	CS40-DIR-16	A..40...	49	35	26	90°	16..IR	
30.221156	CS40-DIL-16	A..40...	49	35	26	90°	16..IL	
		A..50...	59					
		A..60...	69					

Ersatzteile



Bezeichnung	S6016R	TX4007	OR-SET	DT21R/L	V6017	OR-CS40	DM-05-000	CBR30
-------------	--------	--------	--------	---------	-------	---------	-----------	-------

CS40-SCLC.-12

Bohrstangenkopf CS40

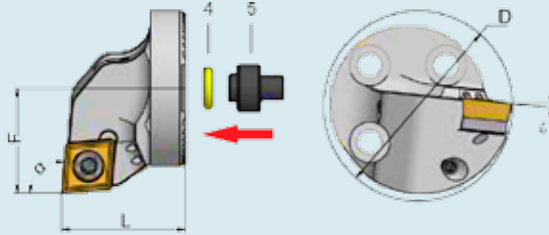

Art.-Nr.	Bezeichnung	Halter	$\varnothing D$ min	L	F	Winkel	WSP	Preis
30.221167	CS40-SCLCR-12	A..40...	49	32	27	95°	CC..1204	
30.221168	CS40-SCLCL-12	A..40...	49	32	27	95°	CC..1204	
		A..50...	59					
		A..60...	69					

Ersatzteile



Bezeichnung	S8012P	B0609	TX4014	OR-CS40	DM-05-000	BTX15
-------------	--------	-------	--------	---------	-----------	-------

CS40-SDQC.-11

Bohrstangenkopf CS40

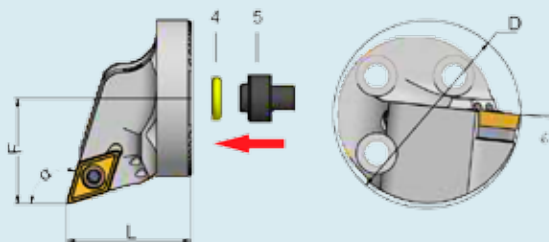

Art.-Nr.	Bezeichnung	Halter	$\varnothing D$ min	L	F	Winkel	WSP	Preis
30.221169	CS40-SDQCR-11	A..40...	48	32	27	107.5°	DC..11T3	
30.221170	CS40-SDQCL-11	A..40...	48	32	27	107.5°	DC..11T3	
		A..50...	58					
		A..60...	68					

Ersatzteile

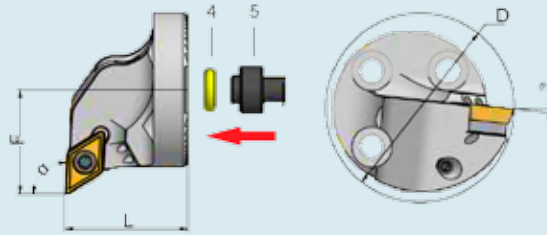

Bezeichnung	S5511P	B0509	TX3513	OR-CS40	DM-05-000	BTX15
-------------	--------	-------	--------	---------	-----------	-------

CS40-SDUC.-11
Bohrstangenkopf CS40

Art.-Nr.	Bezeichnung	Halter	$\varnothing D$ min	L	F	Winkel	WSP	Preis
30.221171	CS40-SDUCR-11	A..40...	49	32	27	93°	DC..11T3	
30.221172	CS40-SDUCL-11	A..40...	49	32	27	93°	DC..11T3	
		A..50...	59					
		A..60...	69					

Ersatzteile

Bezeichnung	S5511P	B0509		TX3513	OR-CS40	DM-05-000	BTX15
-------------	--------	-------	--	--------	---------	-----------	-------

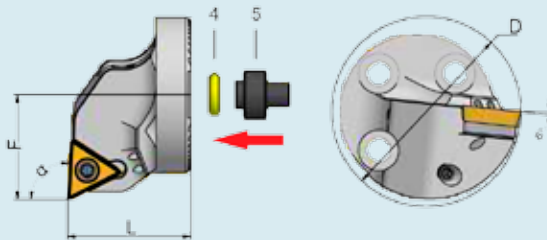
CS40-STUC.-16
Bohrstangenkopf CS40

Art.-Nr.	Bezeichnung	Halter	$\varnothing D$ min	L	F	Winkel	WSP	Preis
30.221175	CS40-STUCR-16	A..40...	49	32	27	93°	TC..16T3	
30.221176	CS40-STUCL-16	A..40...	49	32	27	93°	TC..16T3	
		A..50...	59					
		A..60...	69					

Ersatzteile

Bezeichnung	S6016P	B0509		TX3513	OR-CS40	DM-05-000	BTX15
-------------	--------	-------	--	--------	---------	-----------	-------

CS40-SVUB.-16

Bohrstangenkopf CS40

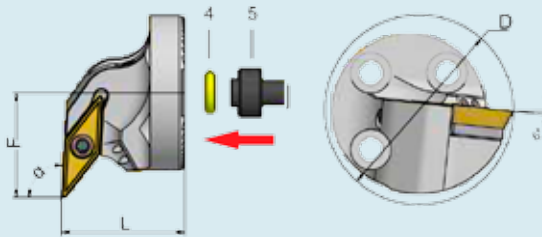

Art.-Nr.	Bezeichnung	Halter	$\varnothing D$ min	L	F	Winkel	WSP	Preis
30.221179	CS40-SVUBR-16	A..40...	49	32	27	93°	VB..1604	
30.221180	CS40-SVUBL-16	A..40...	49	32	27	93°	VB..1604	
		A..50...	59					
		A..60...	69					

Ersatzteile



Bezeichnung

S3516P

B0509

TX3513

OR-CS40

DM-05-000

BTX15

CS40-SVUC.-16

Bohrstangenkopf CS40

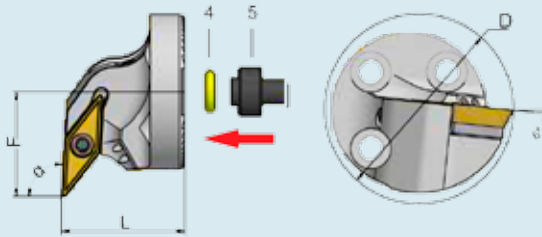

Art.-Nr.	Bezeichnung	Halter	$\varnothing D$ min	L	F	Winkel	WSP	Preis
30.221181	CS40-SVUCR-16	A..40...	49	32	27	93°	VC..1604	
30.221182	CS40-SVUCL-16	A..40...	49	32	27	93°	VC..1604	
		A..50...	59					
		A..60...	69					

Ersatzteile



Bezeichnung

S3516P

B0509

TX3513

OR-CS40

DM-05-000

BTX15

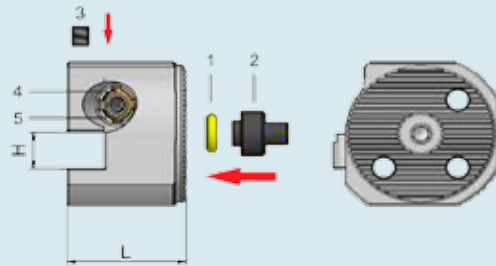
CS40-PU10R/L
SC40 Adapter für Werkzeuge 10mm

Art.-Nr.	Bezeichnung	Halter	$\varnothing D$ min	L	H	Halter	Preis
30.221276	CS40-PU10L	A..40...		32	10	1010	
30.221277	CS40-PU10R	A..40...		32	10	1010	
		A..50...		32	10	1010	
		A..60...		32	10	1010	

Ersatzteile

Bezeichnung	GR0620	SF13990	BS13989	OR-CS40	DM-05-000	BTX15
-------------	--------	---------	---------	---------	-----------	-------

CS40-XXR/L
Rohling CS40

Art.-Nr.	Bezeichnung	Halter	$\varnothing D$ min	L	Preis
		A..40...	54	36	
		A..40...	54	36	
		A..50...	54	36	
		A..60...	54	36	

Ersatzteile

Bezeichnung	OR-CS40	DM-05-000
-------------	---------	-----------

CS40-CIG.-20-11 Bohrstangenkopf CS40

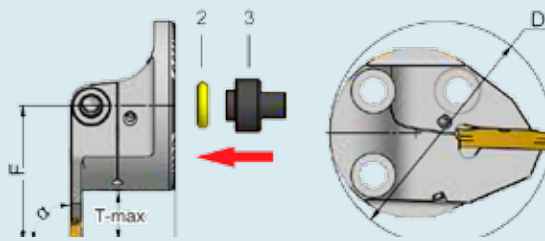

Art.-Nr.	Bezeichnung	Halter	$\varnothing D$ min	L	F	Winkel	W	T-max	WSP	Preis
30.221137	CS40-CIGR-20-11	A..40...	52.5	25	32	90°	2.0	11	CTSN 22-20	
30.221138	CS40-CIGL-20-11	A..40...	52.5	25	32	90°	2.0	11	CTSN 22-20	
		A..50...	62.5							
		A..60...	72.5							

Ersatzteile



Bezeichnung	VB0518	OR-CS40	DM-05-000	CBR40
-------------	--------	---------	-----------	-------

CS40-CIG.-30-11 Bohrstangenkopf CS40

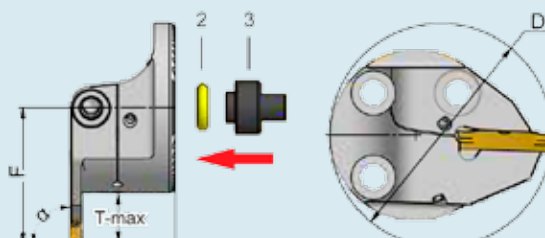

Art.-Nr.	Bezeichnung	Halter	$\varnothing D$ min	L	F	Winkel	W	T-max	WSP	Preis
30.221139	CS40-CIGR-30-11	A..40...	52.5	25	32	90°	2.0	11	CTSN 22-20	
30.221140	CS40-CIGL-30-11	A..40...	52.5	25	32	90°	2.0	11	CTSN 22-20	
		A..50...	62.5							
		A..60...	72.5							

Ersatzteile



Bezeichnung	VB0518	OR-CS40	DM-05-000	CBR40
-------------	--------	---------	-----------	-------

CS40-CIG.-40-11 Bohrstangenkopf CS40

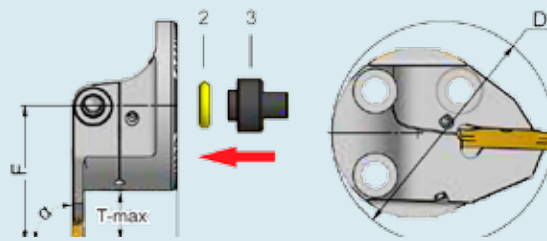

Art.-Nr.	Bezeichnung	Halter	$\varnothing D$ min	L	F	Winkel	W	T-max	WSP	Preis
30.221141	CS40-CIGL-40-11	A..40...	52.5	25	32	90°	4.0	11	CTSN 25-40	
30.221142	CS40-CIGR-40-11	A..40...	52.5	25	32	90°	4.0	11	CTSN 25-40	
		A..50...	62.5							
		A..60...	72.5							

Ersatzteile



Bezeichnung	VB0518	OR-CS40	DM-05-000	CBR40
-------------	--------	---------	-----------	-------

CS40-CIG.-50-11 Bohrstangenkopf CS40

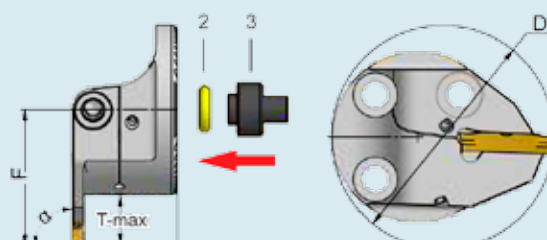

Art.-Nr.	Bezeichnung	Halter	$\varnothing D$ min	L	F	Winkel	W	T-max	WSP	Preis
30.221143	CS40-CIGR-50-11	A..40...	52.5	25	32	90°	2.0	11	CTSN 25-50	
30.221144	CS40-CIGL-50-11	A..40...	52.5	25	32	90°	2.0	11	CTSN 25-50	
		A..50...	62.5							
		A..60...	72.5							

Ersatzteile



Bezeichnung	VB0518	OR-CS40	DM-05-000	CBR40
-------------	--------	---------	-----------	-------

MSS-ANS-

MSS Bohrstangen-Halter mit Dämpfung

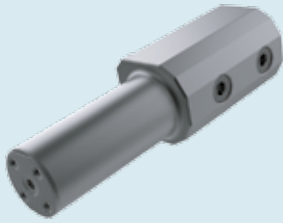

Art.-Nr.	Bezeichnung	D	Länge x D	L	Preis
30.221286	MSS-ANS40-120	40	3 x D	120	
30.221287	MSS-ANS40-160	40	4 x D	180	
30.221288	MSS-ANS50-150	50	3 x D	150	
30.221289	MSS-ANS50-200	50	4 x D	200	

MSS-AFS-

MSS Bohrstangen-Halter mit HM-Kern



Art.-Nr.	Bezeichnung	D	Länge x D	L	Preis
30.221296	MSS-AFS40-280	40	7 x D	280	
30.221297	MSS-AFS40-400	40	10 x D	400	
30.221298	MSS-AFS50-350	50	7 x D	350	
30.221299	MSS-AFS50-500	50	10 x D	500	

MSS-E4-ER..

MSS ER-Grundhalter



Art.-Nr.	Bezeichnung	Preis
30.221300	MSS-E4-ER16	
30.221301	MSS-E4-ER20	
30.221302	MSS-E4-ER25Q	
30.221303	MSS-E4-ER32	
30.221304	MSS-E4-ER40	

BMT45 /55 /65 /75

BMT Grundhalter



Art.-Nr.	Bezeichnung	D	Länge x D	L	Preis
30.222323	MSS-BMT45-045				
30.222324	MSS-BMT55-040				
30.222325	MSS-BMT65-052				
30.222326	MSS-BMT75-045				

BMT40 / BMT 60

BMT (DMG-MORI) Grundhalter



Art.-Nr.	Bezeichnung	D	Länge x D	L	Preis
30.222327	MSS-BMT40-055				
30.222328	MSS-BMT60-060				

BG2 / BG3

BIGLIA Grundhalter



Art.-Nr.	Bezeichnung	D	Länge x D	L	Preis
30.222329	MSS-BG2-060				
30.222330	MSS-BG3-055				

DS1 / DS2

DOOSAN STATIC Grundhalter



Art.-Nr.	Bezeichnung	D	Länge x D	L	Preis
30.222331	MSS-DS1-035				
30.222332	MSS-DS2-040				

TKT2

TAKISAWA TAIWAN Grundhalter



Art.-Nr.	Bezeichnung	D	Länge x D	L	Preis
30.222333	MSS-TKT2-070				

NKM55

NAKAMURA (CMZ) Grundhalter



Art.-Nr.	Bezeichnung	D	Länge x D	L	Preis
30.222334	MSS-NKM55-035				

CMZ30

CMZ (DMG-MORI) Grundhalter



Art.-Nr.	Bezeichnung	D	Länge x D	L	Preis
30.222335	MSS-CMZ30-035				

MZK40 / MZK50

MAZAK Grundhalter



Art.-Nr.	Bezeichnung	D	Länge x D	L	Preis
30.222336	MSS-MZK40-110				
30.222337	MSS-MZK50-170				

Drehen
Tournage



Fräsen
Fraisage



Bohren
Perçage



Wendepplatten
Plaquettes



**Vollhartmetall-, Pulver-HSS-
und HSS-Werkzeuge**
*Outils en carbure monobloc,
HSS et HSS fritté*

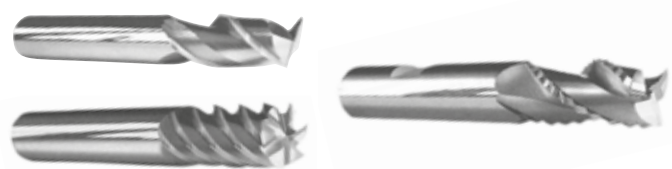

Werkzeugaufnahmen
Porte-outils



Spannmittel
Moyen de serrage



Geräte
Appareils

